

ALPINE **SERVICE MANUAL**

FM/MW/LW/RDS Compact Disc Receiver

MX MP3

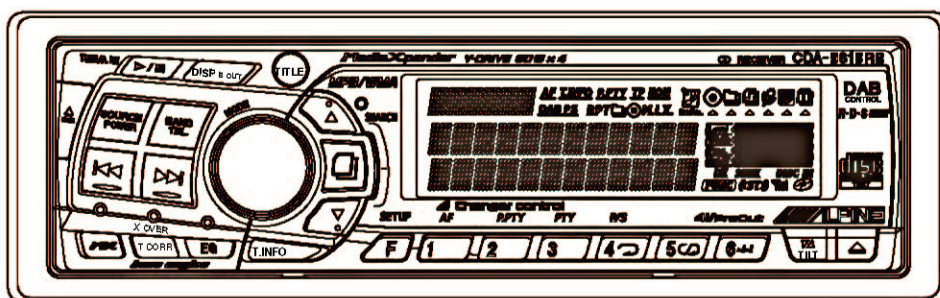

(CDA-9815RB)

3 / 03-A
68E35096S01

CDA-9815RB/ CDA-9813R

Block Diagram

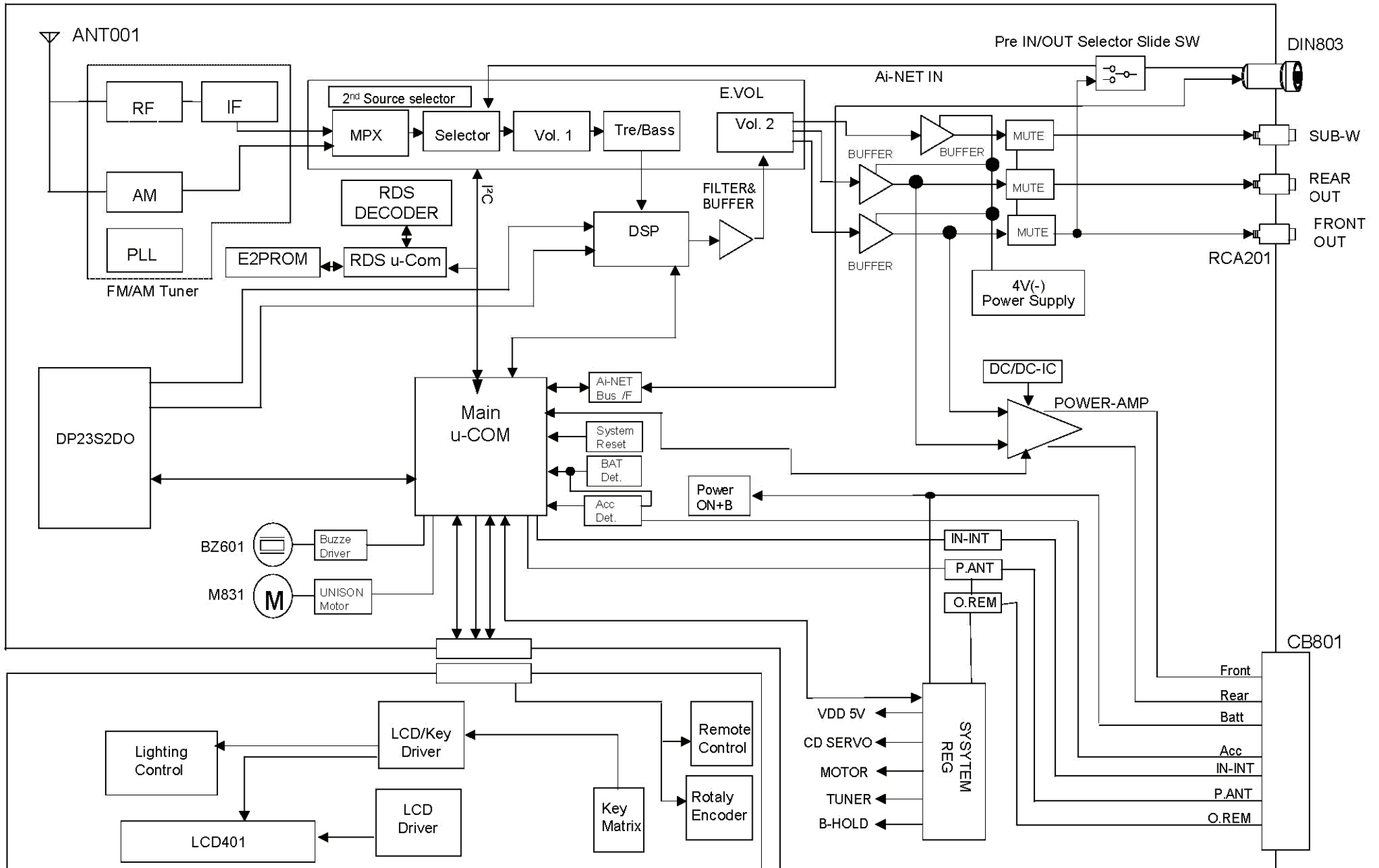

Schematic Diagram (1/8)

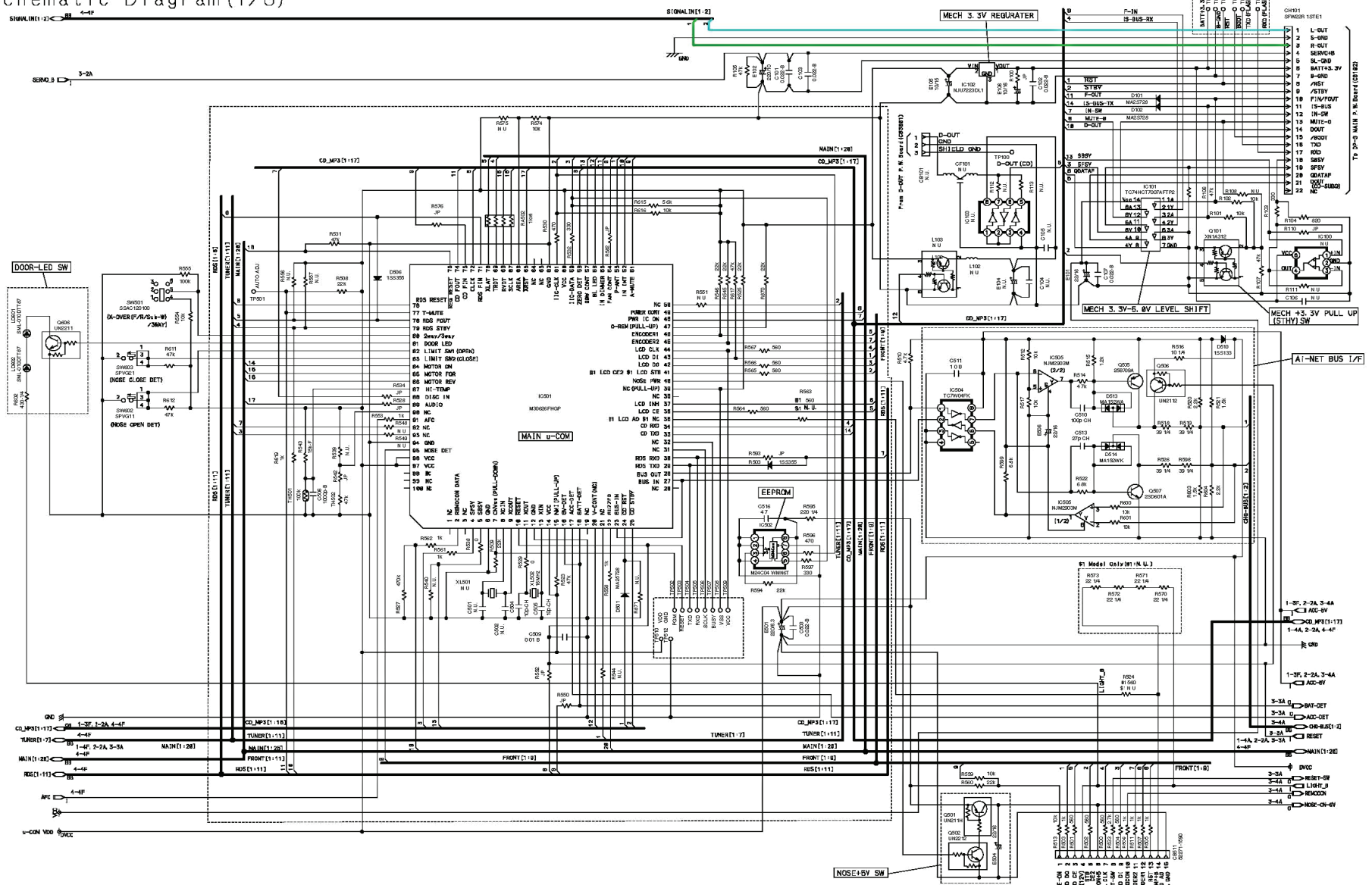

MAIN P.W. Board (1/4)
 NOTE:N.U. is Not Used Parts.

NOTE:#1:For CDA-9815RB Model Only,
 #1:For CDA-9813R Model Only,
 Others:Common.

GH511
 ASSY/JANIZON COHN 02R

Schematic Diagram (2/8)

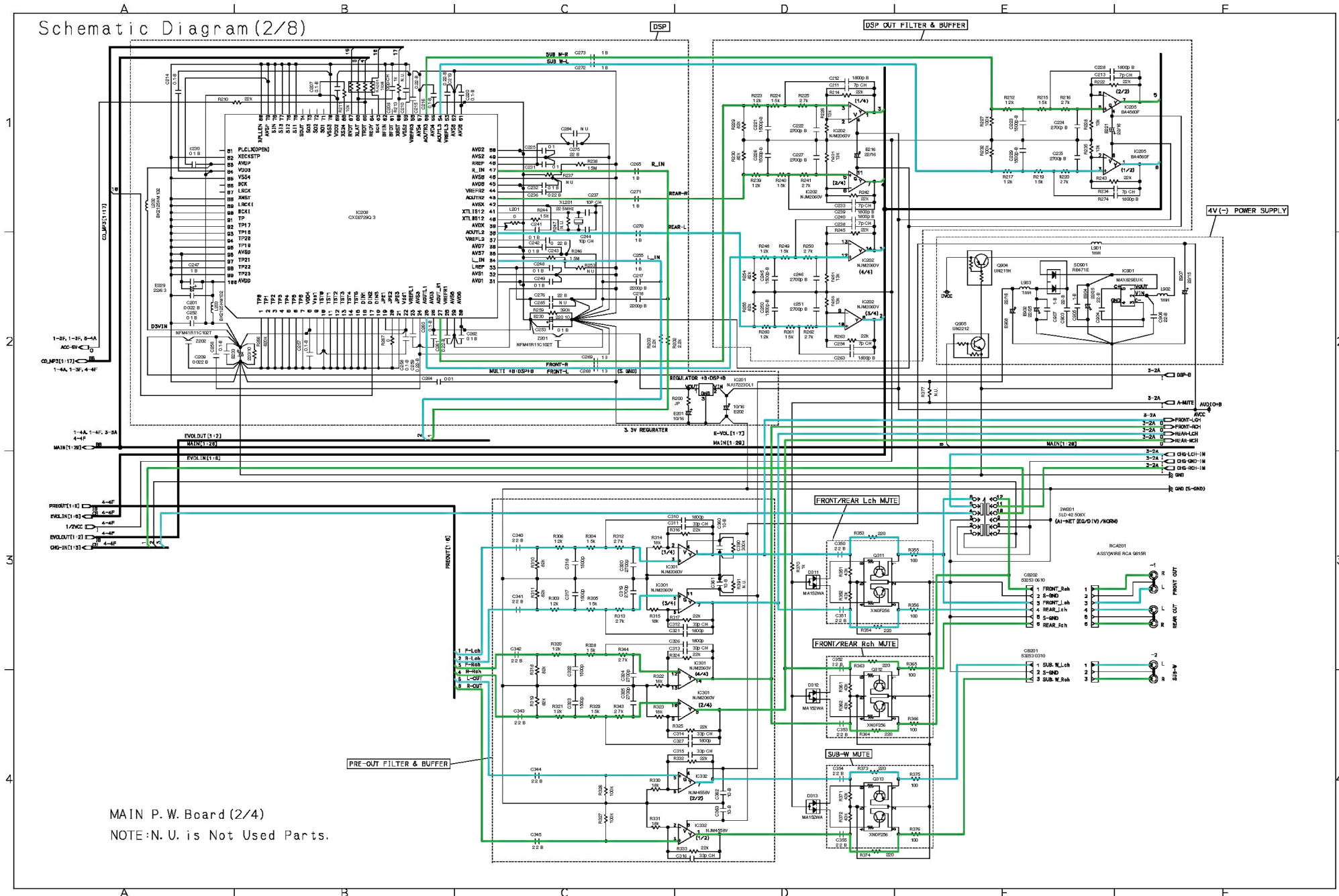

MAIN P.W. Board (2/4)
 NOTE: N. U. is Not Used Parts.

Schematic Diagram (3/8)

NOTE:#1:For CDA-9815RB Model Only,
\$1:For CDA-9813R Model Only,
Others:Common.

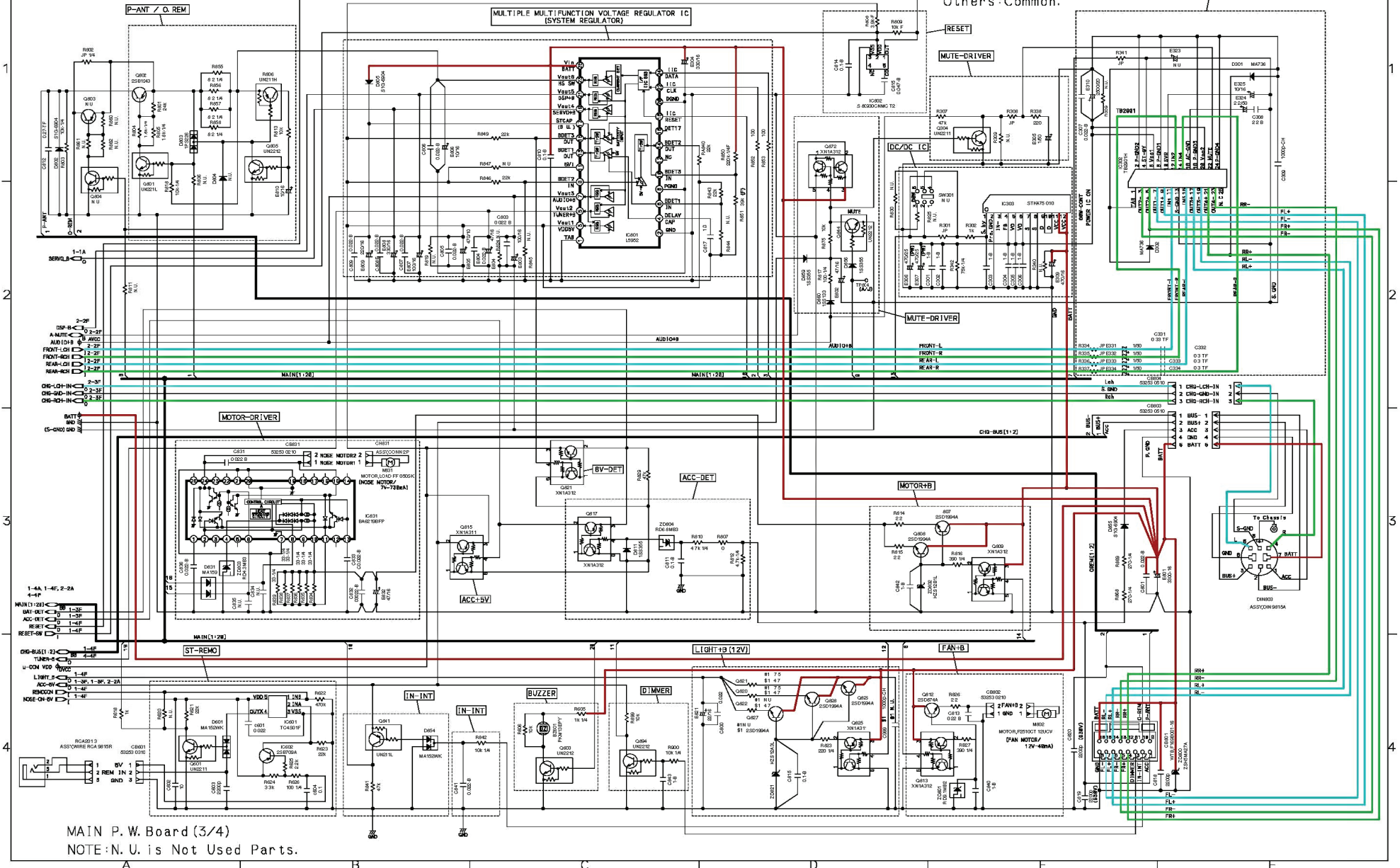

MAIN P.W. Board (3/4)

NOTE:N. U. is Not Used Parts.

Schematic Diagram (4/8)

MAIN P.W. Board (4/4)
NOTE: N. U. is Not Used Parts.

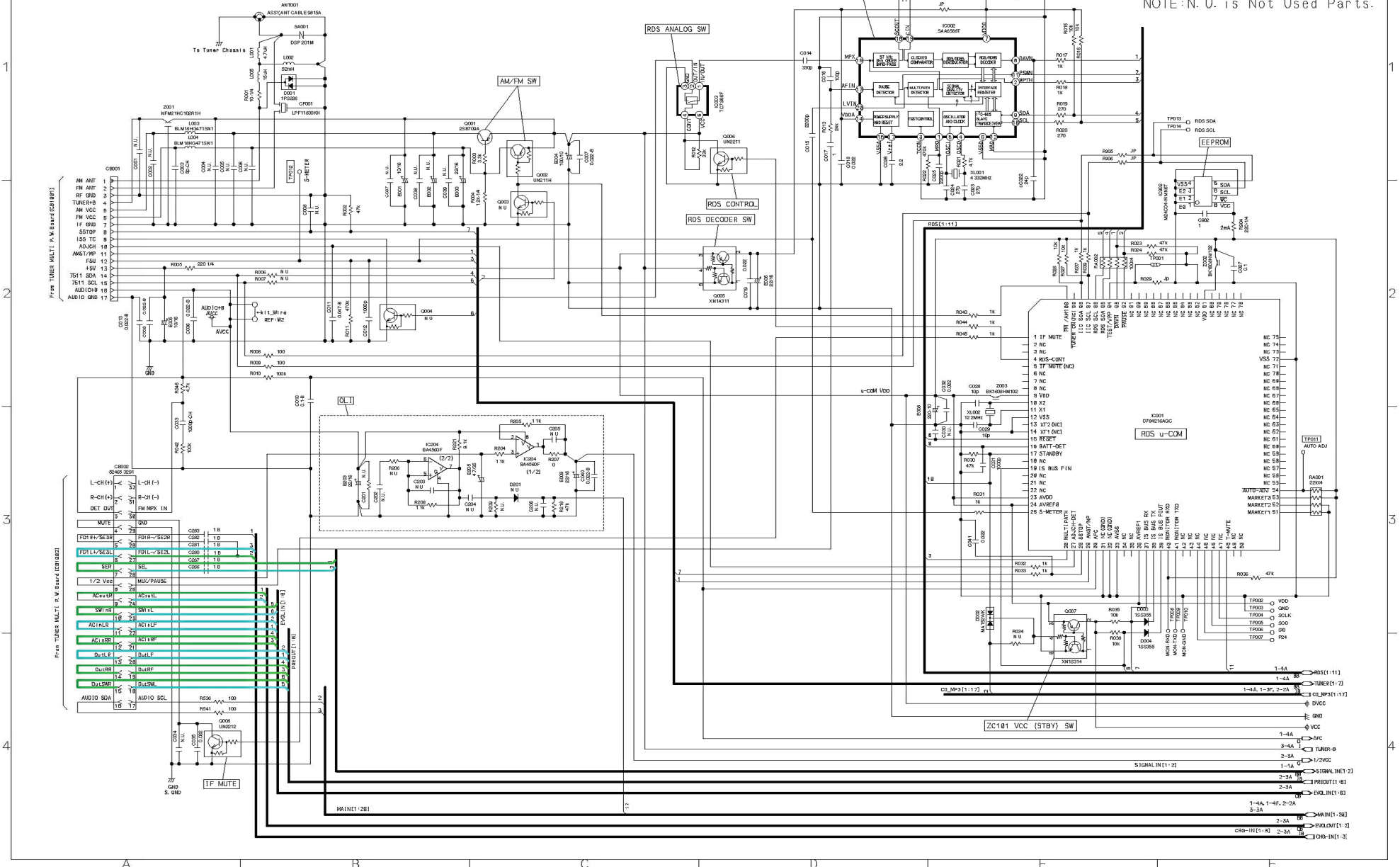

Schematic Diagram (5/8)

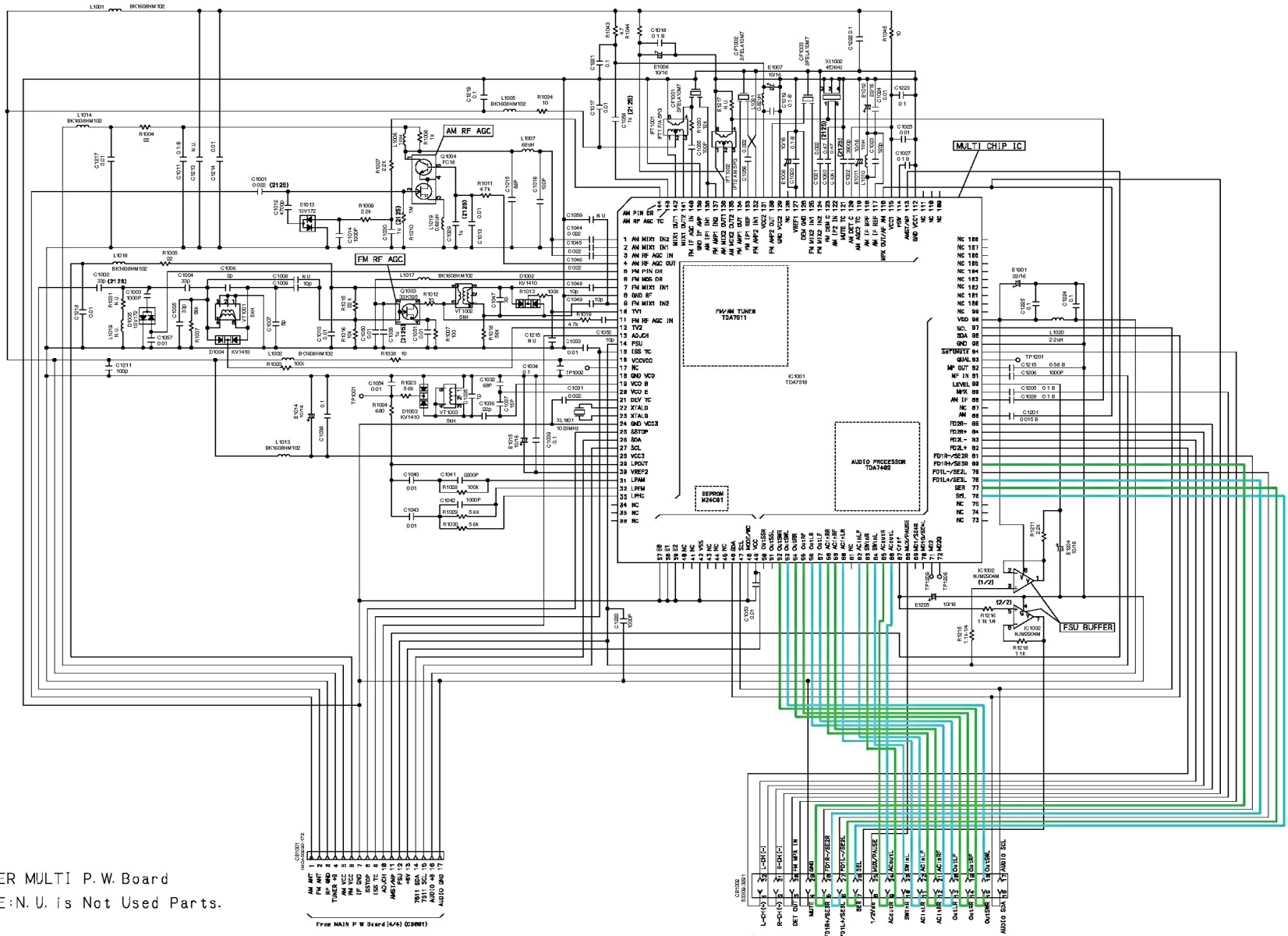

TUNER MULTI P.W. Board
NOTE: N.U. is Not Used Parts.

From MAIN P.W. Board (4/4) (C0981)

From MAIN P.W. Board (4/1) (C0982)

Schematic Diagram (6/8)
 <CDA-9815RB Model Only>

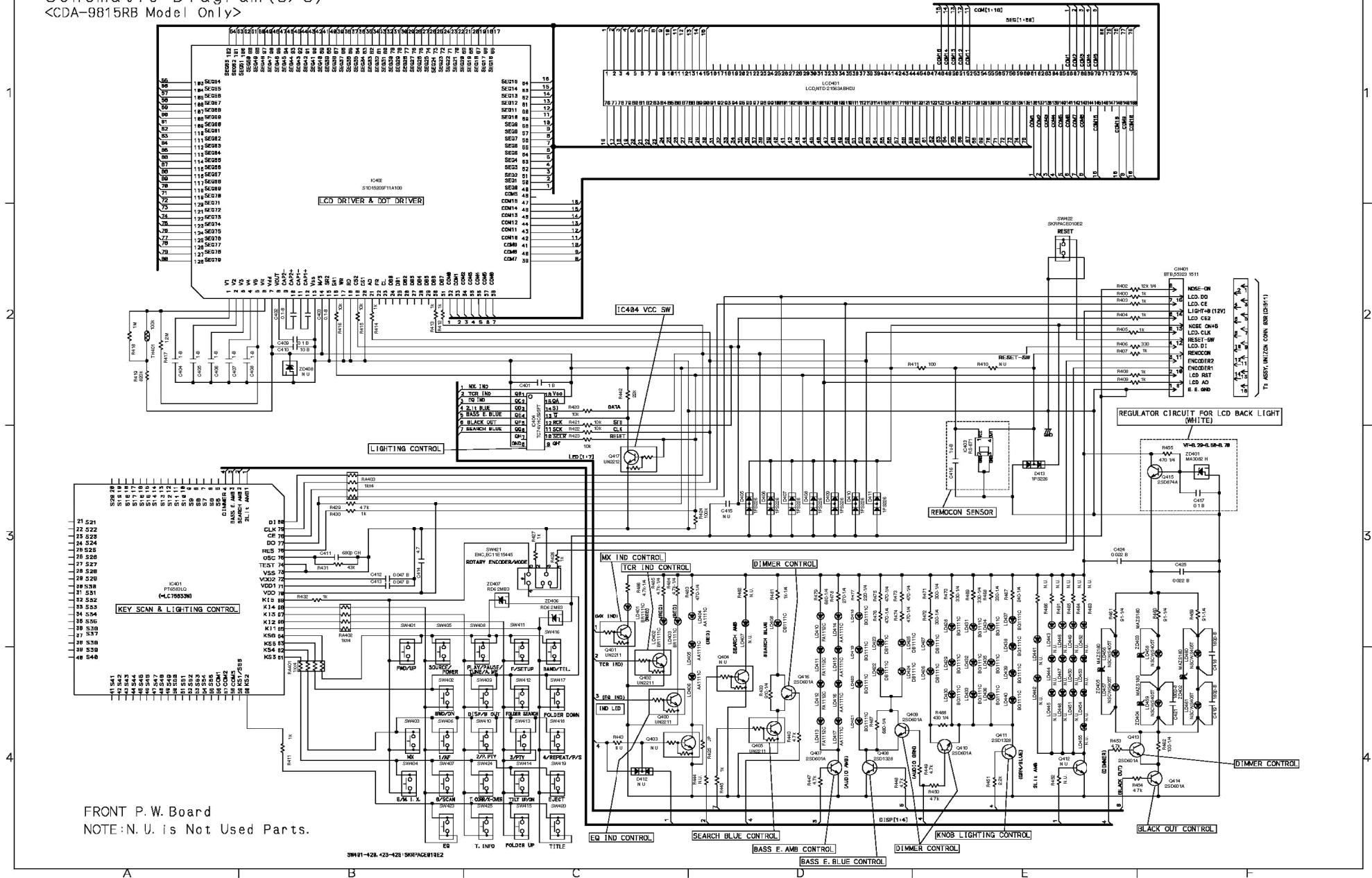

Schematic Diagram (7/8)

<CDA-9813R Model Only>

FRONT P.W. Board
NOTE: N.U. is Not Used Parts.

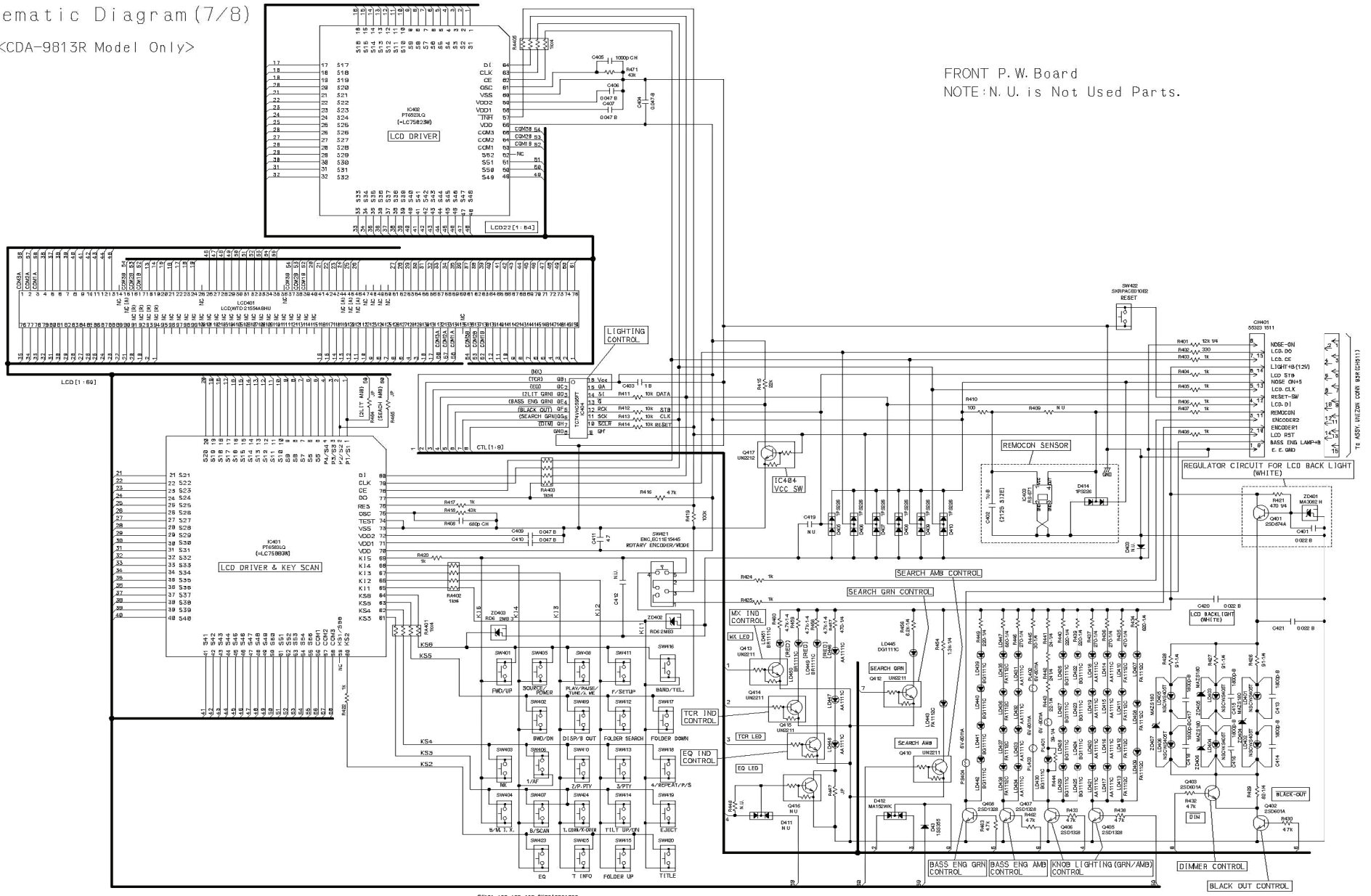

SW401-428, 423-425, 5KRPAE#10E2

Schematic Diagram (8/8)

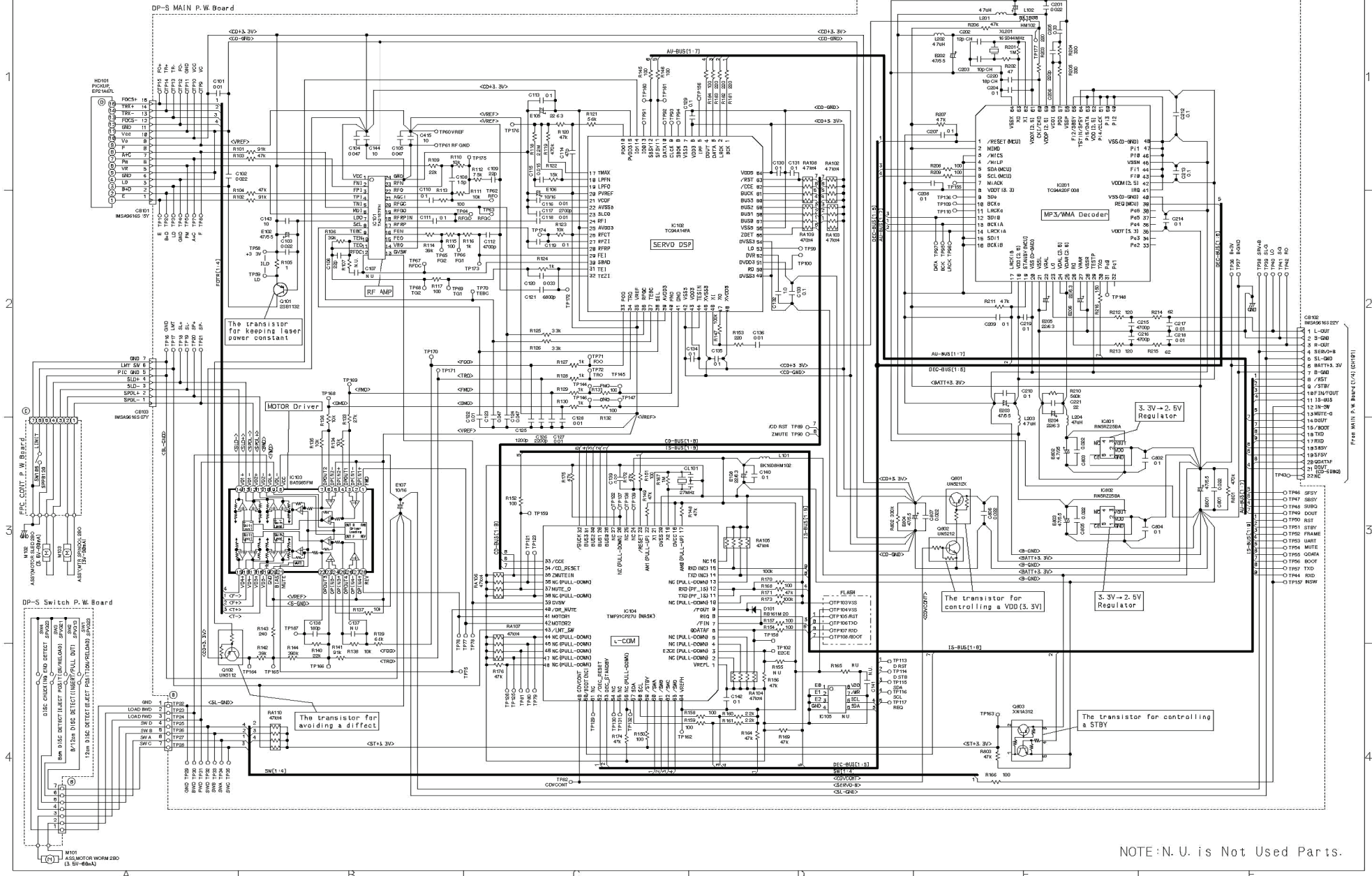

NOTE: N. U. is Not Used Parts.

Terminal Voltage of IC/TR

IC001								
1	0		34	NC		68	NC	
2	NC		35	NC		69	NC	
3	NC		36	4.94		70	NC	
4	0		37	PS		71	NC	
5	NC		38	PS		72	0	
6	NC		39	PS		73	NC	
7	NC		40	PS		74	NC	
8	NC		41	PS		75	NC	
9	4.93		42	NC		76	NC	
10	CLK		43	NC		77	NC	
11	CLK		44	NC		78	NC	
12	0		45	NC		79	NC	
13	NC		46	NC		80	NC	
14	0		47	NC		81	4.94	
15	4.92		48	4.94		82	NC	
16	4.92		49	NC		83	NC	
17	4.91		50	NC		84	NC	
18	NC		51	0		85	NC	
19	PS		52	0		86	NC	
20	NC		53	4.94		87	NC	
21	NC		54	4.94		88	NC	
22	NC		55	NC		89	NC	
23	4.94		56	NC		90	NC	
24	4.94		57	NC		91	NC	
25	0.43 to 4.74	changing Voltage by Receiving	58	NC		92	0	
			59	NC		93	4.72	
26	0		60	NC		94	0	
27	0.1		61	NC		95	PS	
28	3.56		62	NC		96	PS	
29	2.17		63	NC		97	PS	
30	0		64	NC		98	PS	
31	0		65	NC		99	NC	
32	0		66	NC		100	8.23	MW,LW
33	0		67	NC			/0.15	/FM

IC002							
1	0	6	0	11	0	16	2.41
2	0	7	4.83	12	0	17	2.41
3	0	8	452	13	0	18	2.41
4	CLK	9	PS	14	4.83	19	2.41
5	CLK	10	PS	15	0	20	2.41

IC003	
1	3.08
2	3.08
3	0
4	8.23
5	8.23

IC101			
1	PS	8	0
2	PS	9	0
3	PS	10	0
4	PS	11	0
5	0	12	0
6	NC	13	0
7	0	14	4.19

IC102	
1	3.52
2	4.93
3	0

IC201	
1	3.32
2	8.45
3	0

IC202			
1	4.19	8	4.19
2	4.18	9	4.18
3	4.14	10	4.14
4	8.45	11	0
5	4.19	12	4.18
6	4.19	13	4.18
7	4.19	14	4.19

IC204	
1	4.17
2	4.17
3	4.17
4	0
5	8.45
6	8.45
7	8.44
8	8.44

IC205	
1	4.18
2	4.17
3	4.13
4	0
5	4.13
6	4.17
7	4.18
8	8.45

IC208									
1	0	21	0	41		61	0	81	NC
2	0	22	3.25	42	0	62	0	82	0
3	0	23	1.64	43	0	63	PS	83	3.25
4	0	24	0	44	1.65	64	NC	84	3.25
5	0	25	1.65	45	3.32	65	4.87	85	0
6	0	26	3.32	46	0	66	PS	86	NC
7	0	27	1.66	47	1.56	67	PS	87	NC
8	3.25	28	1.64	48	0	68	3.25	88	0
9	0	29	1.64	49	0	69	3.25	89	0
10	0	30	0	50	3.32	70	0	90	0
11	0	31	3.32	51	3.3	71	NC	91	0
12	0	32	3.32	52	0	72	NC	92	0
13	0	33	0	53	1.64	73	NC	93	0
14	0	34	1.66	54	1.66	74	NC	94	0
15	0	35	0	55	3.32	75	0	95	0
16	0	36	3.32	56	1.66	76	0	96	0
17	PS	37	0	57	0	77	0	97	0
18	0	38	1.62	58	1.64	78	0	98	0
19	3.25	39	3.32	59	0	79	0	99	0
20	0	40		60	PS	80	0	100	3.25

IC301			
1	0	8	0
2	0	9	0
3	0	10	0
4	0	11	-8.1
5	8.42	12	0
6	0	13	0
7	0	14	0

IC303					
	60W OFF/ON			60W OFF/ON	
1	0	4.58	7	0	0
2	0	0	8	0	0
3	NC		9	14.41	14.41
4	14.14	17.1	10	14.41	14.41
5	14.14	17.1	11	14.4	14.41
6	14.14	17.1	12	14.41	14.41

IC302						
1	0		9	6.87	18	0
2	0		10	8.6	19	6.85
3	6.89		11	3.51	20	14.14
4	4.93/0	PIC ON/OFF	12	3.53	21	6.83
5	6.81		13	0	22	8.22
6	14.14		14	3.53	23	6.89
7	6.87		15	3.53	24	0
8	0		16	3.59	25	NC
			17	6.87		

IC332	
1	0
2	0
3	0
4	-8.11
5	0
6	0
7	0
8	8.43

IC401(CDA-9815R Model Only)								
1	NC		21	NC	41	NC	61	4.89
2	NC		22	NC	42	NC	62	4.87
3	0/4.42	TCORR,EQ OFF/ON	23	NC	43	NC	63	4.87
4	0/4.51	DIMMER OFF/ON	24	NC	44	NC	64	4.87
5	NC		25	NC	45	NC	65	0.35
6	NC		26	NC	46	NC	66	0.34
7	NC		27	NC	47	NC	67	0.31
8	NC		28	NC	48	NC	68	0.33
9	NC		29	NC	49	NC	69	0.31
10	NC		30	NC	50	NC	70	4.96
11	NC		31	NC	51	NC	71	2.37
12	NC		32	NC	52	NC	72	1.2
13	NC		33	NC	53	NC	73	0
14	NC		34	NC	54	NC	74	0
15	NC		35	NC	55	NC	75	3.89
16	NC		36	NC	56	NC	76	4.44
17	NC		37	NC	57	NC	77	PS
18	NC		38	NC	58	NC	78	PS
19	NC		39	NC	59	NC	79	PS
20	NC		40	NC	60	4.9	80	PS

IC401(CDA-9813R Model Only)								
1	0/4.51	OFF/ON	21	PS	41	PS	61	4.92
2	0/4.89	OFF/ON	22	PS	42	PS	62	4.92
3	PS		23	PS	43	PS	63	4.92
4	PS		24	PS	44	PS	64	4.92
5	PS		25	PS	45	PS	65	0.03
6	PS		26	PS	46	PS	66	0.03
7	PS		27	PS	47	PS	67	0.03
8	PS		28	PS	48	PS	68	0.03
9	PS		29	PS	49	PS	69	0.03
10	PS		30	PS	50	PS	70	4.42
11	PS		31	PS	51	PS	71	3.17
12	PS		32	PS	52	PS	72	1.56
13	PS		33	PS	53	PS	73	0
14	PS		34	PS	54	PS	74	0
15	PS		35	PS	55	PS	75	CLK
16	PS		36	PS	56	PS	76	4.47
17	PS		37	PS	57	PS	77	PS
18	PS		38	PS	58	PS	78	PS
19	PS		39	PS	59	NC	79	PS
20	PS		40	PS	60	4.92	80	PS

IC402(CDA-9815R Model Only)									
1	3.3	27	NC	53	PS	79	PS	104	PS
2	1.76	28	NC	54	PS	80	PS	105	PS
3	0.21	29	NC	55	PS	81	PS	106	PS
4	-1.38	30	PS	56	PS	82	PS	107	PS
5	-2.94	31	PS	57	PS	83	PS	108	PS
6	0	32	PS	58	PS	84	PS	109	PS
7	4.9	33	PS	59	PS	85	PS	110	PS
8	-9.4	34	PS	60	PS	86	PS	111	PS
9	-7.1	35	PS	61	PS	87	PS	112	PS
10	2.47	36	PS	62	PS	88	PS	113	PS
11	-2.37	37	PS	63	PS	89	PS	114	PS
12	0	38	PS	64	PS	90	PS	115	PS
13	4.9	39	PS	65	PS	91	PS	116	PS
14	0	40	PS	66	PS	92	PS	117	PS
15	4.43	41	PS	67	PS	93	PS	118	PS
16	0	42	PS	68	PS	94	PS	119	PS
17	0	43	PS	69	PS	95	PS	120	PS
18	PS	44	PS	70	PS	96	PS	121	PS
19	PS	45	PS	71	PS	97	PS	122	PS
20	PS	46	PS	72	PS	98	PS	123	PS
21	PS	47	PS	73	PS	99	PS	124	PS
22	NC	48	NC	74	PS	100	PS	125	PS
23	NC	49	PS	75	PS	101	PS	126	PS
24	NC	50	PS	76	PS	102	PS	127	PS
25	NC	51	PS	77	PS	103	PS	128	PS
26	NC	52	PS	78	PS				

IC402(CDA-9813R Model Only)							
1	PS	17	PS	33	PS	49	PS
2	PS	18	PS	34	PS	50	PS
3	PS	19	PS	35	PS	51	PS
4	PS	20	PS	36	PS	52	NC
5	PS	21	PS	37	PS	53	PS
6	PS	22	PS	38	PS	54	PS
7	PS	23	PS	39	PS	55	PS
8	PS	24	PS	40	PS	56	4.92
9	PS	25	PS	41	PS	57	4.5
10	PS	26	PS	42	PS	58	3.17
11	PS	27	PS	43	PS	59	1.56
12	PS	28	PS	44	PS	60	CLK
13	PS	29	PS	45	PS	61	PS
14	PS	30	PS	46	PS	62	PS
15	PS	31	PS	47	PS	63	PS
16	PS	32	PS	48	PS	64	PS

IC403	
1	4.74
2	0
3	0
4	PS

IC404(CDA-9815R Model Only)					
1	0/4.89	TCR IND OFF/ON	9	NC	
2	0/4.89	EQ IND. OFF/ON	10	4.89	
3	4.89	2LIT IND	11	4.49	
4	4.86/0	BASE E GRN	12	4.93	
5	4.89/0	BLKOUT	13	0	
6	0/PS	SEARCH IND. OFF/ON	14	PS	
7	NC		15	0/4.89	MX IND. OFF/ON
8	0		16	4.9	

IC404(CDA-9813R Model Only)					
1	0/4.86	TCR IND. OFF/ON	9	NC	
2	0/4.86	EQ IND. OFF/ON	10	4.49	
3	4.88/0	2LIT GRN	11	4.49	
4	4.88/0	BASS E GRN	12	4.94	
5	4.88/0	BALCK OUT	13	0	
6	4.88	SEARCH GRN	14	PS	
7	0/4.88	DIMMER OFF/ON	15	0/4.88	MX IND. OFF/ON
8	0		16	4.92	

IC501-1					
1	NC		31	NC	
2	PS		32	NC	
3	NC		33	PS	
4	PS		34	PS	
5	PS		35	PS	
6	0		36	PS	
7	0		37	PS	
8	NC		38	0	
9	NC		39	4.93	
10	4.95		40	PS	
11	CLK		41	PS	
12	0		42	PS	
13	CLK		43	PS	
14	4.94		44	4.59	
15	4.93		45	4.92	
16	4.95		46	4.92	
17	4.89		47	4.93	
18	4.91		48	4.93/2.58	POWER-AMP ON/OFF
19	NC		49	4.92	
20	0		50	NC	
21	0.08/4.17	FM/AM	51	4.92/0	A-MUTE OFF/ON
22	0/PS	BUZZER OFF/ON	52	0/4.87	IN-INT OFF/ON
23	PS		53	4.93	
24	PS		54	0/4.92	FAN OFF/ON
25	PS		55	4.92/0	DIMMER OFF/ON
26	NC		56	4.91	
27	PS		57	0/4.91	60W-OUT OFF/ON
28	PS		58	4.91/0	0 Bit detect/others
29	PS		59	PS	
30	PS		60	4.93	

IC501-2					
61	PS		81	0/4.5	NOSE CLOSE/OPEN
62	0		82	4.9/0	OTHERS/OPEN DETECT
63	NC		83	4.9/0	OTHERS/CLOSE DETECT
64	NC		84	0/4.93	MOTOR OFF/ON
65	4.93		85	0/4.93	MOTOR OFF/ON
66	0		86	0/4.93	MOTOR OFF/ON
67	PS		87	4.05	
68	PS		88	0/3.3	CD detecting/others
69	PS		89	0	
70	4.93		90	0	
71	PS		91	3	
72	0		92	0.15	
73	PS		93	0.43 to 4.74	changing Voltage by Receiving
74	0		94	0	
75	4.93		95	2.46/4.93	others/NOSE detach
76	0		96	4.94	
77	4.95		97	4.94	
78	PS		98	NC	
79	4.94		99	NC	
80	0/4.96	2WAY/3WAY	100	NC	

IC502	
1	0
2	0
3	4.89
4	0
5	4.89
6	PS
7	0
8	4.89

IC504	
1	PS
2	PS
3	0
4	0
5	NC
6	PS
7	PS
8	4.89

IC505	
1	PS
2	PS
3	PS
4	0
5	2.45
6	PS
7	PS
8	PS

IC601	
1	PS
2	PS
3	0
4	PS
5	4.89

IC801									
1	0	6	4.93	11	NC	16	NC	21	3.26
2	0	7	8.46	12	NC	17	13.6	22	PS
3	4.94	8	0	13	NC	18	4.92	23	14.14
4	4.26	9	4.93	14	5.1	19	6.92	24	PS
5	8.27	10	2.7	15	2.72	20	0	25	14.4

IC802	
1	4.92
2	4.92
3	0
4	NC
5	0

IC831								
1	0		10	12.66		18	NC	
2	NC		11	12.66		19	0	
3	NC		12	NC		20	0	
4	0/3.77	MOTOR OFF/ON	13	0		21	0	
5	NC		14	NC		22	NC	
6	0/4.36	MOTOR OFF/ON	15	0/4.05	MOTOR OFF/ON	23	NC	
7	0		16	NC		24	0/4.05	MOTOR OFF/ON
8	0/4.36	MOTOR OFF/ON	17	NC		25	NC	
9	NC							

IC901	
1	-2.05
2	4.78
3	-4.26
4	0
5	2.52

IC902			
1	0	5	PS
2	0	6	PS
3	0	7	0
4	0	8	4.94

IC1001											
	FM	AM		FM	AM		FM	AM		FM	AM
1	0	2.4	37	0	0	73	0	0	109	0	0
2	0	2.4	38	0	0	74	0	0	110	0	0
3	0	2.39	39	0	0	75	0	0	111	0	0
4	0	2.07	40	0	0	76	4.28	4.31	112	0	0
5	1.19	0	41	0	0	77	4.28	4.31	113	0.08	4.17
6	6.05	7.76	42	0	0	78	4.28	4.31	114	4.23	4.19
7	1.98	0	43	0	0	79	4.28	4.31	115	8.1	8.05
8	0	0	44	0	0	80	4.28	4.31	116	3	2.89
9	1.98	0	45	0	0	81	4.28	4.31	117	0.03	3.76
10	3.16	4.82	46	4.92	4.92	82	4.28	4.31	118	0.03	3.68
11	0.76	0.77	47	4.92	4.92	83	4.28	4.31	119	0.08	2.97
12	2.92	3.82	48	0	0	84	4.28	4.31	120	0	2.99
13	0.08	0.11	49	4.92	4.92	85	4.28	4.31	121	2.84	1.65
14	4.13	4.88	50	4.32	4.32	86	4.28	4.31	122	0.05	3.76
15	0.02	0	51	4.32	4.32	87	0.03	0.03	123	2.55	2.53
16	8.18	8.17	52	4.32	4.32	88	4.28	4.33	124	4.23	4.26
17	0	0	53	4.32	4.32	89	4.3	4.31	125	4.28	4.26
18	0	0	54	4.32	4.32	90	4.13	4.89	126	0	0
19	3.79	3.79	55	4.32	4.32	91	0	0	127	4.98	4.99
20	3.32	3.35	56	4.32	4.32	92	4.2	4.23	128	0	0.02
21	3.52	4.22	57	4.32	4.32	93	0.21	0.23	129	0	0
22	CLK	CLK	58	4.3	4.3	94	3.6	3.6	130	3.89	3.77
23	CLK	CLK	59	4.3	4.3	95	0	0	131	7.88	7.82
24	0	0	60	4.3	4.3	96	4.92	4.92	132	1.97	1.9
25	PS	PS	61	0.02	0.02	97	4.92	4.92	133	1.97	1.9
26	4.91	4.91	62	4.3	4.3	98	8.67	8.67	134	3.92	3.82
27	4.91	4.91	63	4.32	4.32	99	0	0	135	8.17	8.1
28	8.21	8.19	64	4.32	4.32	100	0	0	136	8.17	8.11
29	3.18	4.87	65	4.32	4.32	101	0	0	137	1.97	1.9
30	2.49	2.49	66	4.32	4.32	102	0	0	138	1.97	1.9
31	2.49	2.49	67	4.31	4.31	103	0	0	139	0	0
32	2.49	2.49	68	4.31	4.31	104	0	0	140	3.57	3.6
33	2.49	2.48	69	4.31	4.31	105	0	0	141	8.11	8.13
34	0	0	70	4.31	4.31	106	0	0	142	8.11	8.13
35	0	0	71	4.31	4.31	107	0	0	143	6.86	3.57
36	0	0	72	4.31	4.31	108	0	0	144	0	0.3

IC1002			
1	4.06	5	4.06
2	4.06	6	4.08
3	4.06	7	4.08
4	0.00	8	8.65

	1	2	3	4	5	6	
Q311	0	0	0	6.33/0	0	6.33/0	MUTE ON/OFF
Q312	0	0	0	6.33/0	0	6.33/0	MUTE ON/OFF
Q313	0	0	0	6.33/0	0	6.33/0	MUTE ON/OFF

	1	2	3	4	5	
Q005	NC	4.94	4.83	8.26	0	
Q007	NC	4.94	4.94	3.94	0	
Q101	NC	3.3/0	3.32	4.89/0	0	CD/TUNER
Q809	NC	0/14.4	14.4	0/4.93	0	MOTOR OFF/ON
Q813	NC	0/14.4	14.4	0/4.93	0	FAN OFF/ON
Q815	NC	4.88	4.93	4.88	0	
Q817	NC	4.89	4.92	6.1	0	
Q821	NC	4.9	4.93	2.73	0	
Q825	NC	14.34	14.38	4.9	0	
Q872	NC	-7.81/14.3	14.39	0/3.62	-8/0	MUTE OFF/ON
Q1004	7.31	0	0	2.5	3.19	AM

	1	2	3	4	
Q1003	5.99	2.47	0.91	7.81	FM

	E	C	B	
Q001	8.21/8.26	0/8.2	8.2/7.4	FM/MW,LW
Q002	8.26/8.26	8.25/1.98	2.56/8.26	FM/MW,LW
Q006	0	8.23	0	
Q008	0	3.6	0	
Q304	0	8.2/0	0/3.6	MUTE ON/OFF
Q501	4.94	4.9	0	
Q502	0	0	4.9	
Q505	4.88	data signal	4.89	
Q506	4.94	data signal	4.97	
Q507	data signal	data signal	0	
Q601	PS	PS	0	
Q602	4.9	PS	4.93	
Q603	0	14.38/PS	0/PS	Buzzer OFF/ON
Q606	0	9.02/0.12	0/4.9	Door CLOSE/OPEN
Q801	0/14.39	14.37/0.12	0/2.87	CD/FM
Q802	14.34	14.35	13.65	
Q805	0	14.36	0	
Q806	14.68	0	14.36	
Q807	12.54	14.39	13.06	
Q808	12.54	14.39	13.06	
Q812	0/8.51	14.4	0.129.19	FAN OFF/ON
Q826	12.4	13	14.38	
Q828	12.4	13	14.38	
Q841	4.89	0/4.88	4.89/3.15	INT OFF/ON
Q844	0	0/3.61	4.44/0	MUTE OFF/ON
Q894	0	4.89/0	0/10.1	DIMMER OFF/ON
Q904	0	4.8	4.94	
Q905	4.92	0	0	

CDA-9815R MODEL ONLY				
	E	C	B	
Q400	0	10.32/0.04	0/4.87	EQ IND OFF/ON
Q401	0	10.33/0.04	0/4.87	MX IND OFF/ON
Q402	0	10.4/0.1	0/4.89	TCR IND OFF/ON
Q405	0	0	4.47	
Q407	0	6.34/0	0/0.73	TCR/EQ OFF/ON
Q408	0	0/7.45	6.99/0	TCR/EQ OFF/ON
Q409	0.01	0.09/3.5	0.75/0.01	DIMMER OFF/ON
Q410	0.07	0.12/2.43	0.78/0.01	DIMMER OFF/ON
Q411	0	0.61	0.73	
Q413	0.14/0.07	0.15/3.96	0.78/0.01	DIMMER OFF/ON
Q414	0	0.15/3.98	0.78/0	BLACK OUT OFF/ON
Q415	7.65/8.26	11.7/11.89	8.59/8.62	BLACK OUT OFF/ON
Q416	0.08/0.05	0.11/4.2	0.79/0	DIMMER OFF/ON
Q417	0	0	4.49	

CDA-9813R MODEL ONLY				
	E	C	B	
Q401	0	0.61	0.73	
Q402	0	0.17/3.91	0.81/0.05	BLACK OUT OFF/ON
Q403	0.07/0	0.29/1.47	0.92/0.05	DIMMER OFF/ON
Q405	0	7.66/0.07	0.05/0.71	GREEN/AMB
Q406	0	0.5/12.1	0.76/0	GREEN/AMB
Q407	6.42/0	0.1/0.05	0.05/0.7	GREEN/AMB
Q408	0	0.1/12	0.74/0	GREEN/AMB
Q410	0	10.29/0.1	0/4.81	GREEN/AMB
Q412	0	0.07/10.15	4.9/0	GREEN/AMB
Q413	0	10.37/0.05	0/4.91	MX IND OFF/ON
Q414	0	10.35/0.08	0/4.91	TCR IND OFF/ON
Q415	0	10.4/0	0/4.87	EQ IND OFF/ON
Q417	0	0.06	4.51	
Q827	12.4	13	14.38	

[Measuring Conditions]

- 1.Power Supply Voltage : DC13V
- 2.Measuring Meter : Digital Multi Meter
- 3.Measuring Point Reference : Between GND
- 3.Measuring Condition : FM : 98.1MHz
AM : 999kHz
CD : at playing Disc

(CD Deck Mechanism)

IC101								
	CD-DA	MP3		CD-DA	MP3		CD-DA	MP3
1	3.3	3.3	9	1.7	1.7	17	2.6	2.3
2	-	-	10	1.6	1.6	18	1.7	1.7
3	-	-	11	1.6	1.6	19	1.4	1.3
4	1.7	1.7	12	2.5	2.0	20	0.3	0.6
5	1.7	1.7	13	3.3	3.0	21	2.5	2.4
6	0.3	0.2	14	1.6	1.7	22	1.3	1.1
7	2.5	2.5	15	1.6	1.7	23	0.1	1.7
8	2.0	2.0	16	1.6	1.7	24	0.1	0.1

IC102								
	CD-DA	MP3		CD-DA	MP3		CD-DA	MP3
1	1.6	1.7	23	1.6	1.7	45	0.1	0.1
2	1.7	1.7	24	1.7	1.7	46	1.7	1.7
3	0.1	0.1 - 2.3	25	3.3	3.2	47	1.7	1.7
4	1.7	1.7	26	1.7	1.7	48	3.3	3.2
5	0.1	0.1 - 3.3	27	1.7	1.7	49	0.1	0.1
6	3.2	3.2	28	2.6	2.3	50	1.6	1.7
7	0.1	0.1	29	1.7	1.6	51	3.3	3.2
8	0.1 - 3.2	0.1 - 3.2	30	2.5	2.0	52	1.7	1.6
9	0.0	0.0	31	1.6	1.6	53	1.7	1.7
10	3.3	3.2	32	1.7	1.6	54	0.1	0.1
11	0.1	0.1	33	1.7	1.6	55	3.3	0.1 - 3.2
12	0.0	0.0	34	1.7	1.6	56	0.8	0.1
13	3.3	0.1 - 3.2	35	1.7	1.6	57	0.1 - 3.3	0.1 - 3.2
14	3.3	3.2	36	0.2 - 1.2	0.4 - 1.2	58	0.1 - 3.3	0.1 - 3.2
15	3.3	3.2	37	1.7 - 2.6	1.7 - 2.5	59	0.1 - 3.3	0.1 - 3.2
16	1.7	1.7	38	2.0	2.1	60	0.1 - 3.3	0.1 - 3.2
17	1.6	1.6	39	3.3	3.2	61	0.1 - 3.3	0.1 - 3.2
18	1.6	1.7	40	1.6	1.2 - 1.7	62	0.1 - 3.3	0.1 - 3.2
19	1.7	1.7	41	1.8	1.7 - 2.1	63	3.3	3.2
20	1.7	1.7	42	0.1	0.1	64	3.3	3.2
21	1.1	1.1	43	3.3	3.2			
22	0.1	0.1	44	0.1	0.1			

IC103								
	CD-DA	MP3		CD-DA	MP3		CD-DA	MP3
1	0.1	0.1	11	3.8	3.8	21	3.3	3.3
2	1.7	1.7	12	3.0	3.0	22	1.7	1.6
3	1.6	1.7	13	3.3	3.3	23	1.7	1.6
4	1.7	1.7	14	3.6	3.5	24	1.7	1.6
5	1.7	1.7	15	3.6	3.5	25	1.7	1.6
6	1.7	1.7	16	3.2	3.2	26	1.7	1.6
7	1.5	1.5	17	3.4	3.4	27	1.7	1.6
8	7.0	7.0	18	3.4	3.4	28	0.1	0.1
9	0.1	0.1	19	0.1	0.1			
10	0.1	0.1	20	1.7	1.6			

IC104								
	CD-DA	MP3					CD-DA	MP3
1	0.1	0.1	23	3.3	3.3	45	0.1	0.1
2	0.1	0.1	24	0.1	0.1	46	0.1	0.1
3	0.1	0.1	25	0.1	0.1	47	0.1	0.1
4	0.1	0.1	26	0.1	0.1	48	0.1	0.1
5	0.1	0.1	27	0.0	0.0	49	3.3	3.3
6	0.1	0.1	28	0.3 - 3.3	0.4 - 3.2	50	0.1	0.1
7	0.3 - 3.3	0.4 - 3.3	29	0.1 - 3.3	0.1 - 3.2	51	0.1	0.1
8	0.1	0.1 - 3.3	30	0.1 - 3.3	0.1 - 3.1	52	3.3	3.3
9	0.3 - 3.3	0.3 - 3.3	31	0.1 - 3.3	0.1 - 3.1	53	0.1	0.1
10	0.1	0.1	32	0.1 - 3.3	0.1 - 3.1	54	3.3	3.3
11	0.2 - 3.3	0.3 - 3.3	33	0.1 - 3.3	0.1 - 3.1	55	3.3	3.3
12	0.3 - 3.3	0.3 - 3.3	34	3.2	3.2	56	0.1	0.1
13	0.1	0.1	35	0.1	0.1 - 3.2	57	3.3	0.3 - 3.3
14	3.2	3.2	36	0.1	0.1	58	3.3	0.3 - 3.3
15	3.2	3.2	37	0.1	0.1	59	3.3	3.3
16	0.1	0.1	38	0.1	0.1	60	3.3	3.3
17	-	-	39	3.3	3.3	61	0.1	0.1
18	3.3	1.7	40	3.3	3.3	62	0.1	0.1
19	1.6	3.3	41	0.1	0.1	63	0.1	0.1
20	0.1	0.0	42	0.1	0.1	64	3.3	3.3
21	1.6	3.0	43	3.3	3.3			
22	3.3	3.3	44	0.1	0.1			

IC201								
	CD-DA	MP3					CD-DA	MP3
1	3.3	3.3	23	1.3	1.3	45	0.1	0.1
2	3.3	3.3	24	2.6	2.6	46	0.1	0.1
3	0.1	0.1	25	2.6	2.6	47	0.1	0.1
4	0.1	0.1	26	1.3	1.4	48	0.1	0.1
5	3.3	0.4 - 3.3	27	1.3	1.4	49	0.1	0.1
6	3.3	0.4 - 3.3	28	0.1	0.1	50	0.1	0.1
7	3.3	3.3	29	0.1	0.1	51	0.1	0.1
8	3.3	3.3	30	1.9	0.0 - 3.3	52	2.6	2.5
9	0.1	0.1	31	0.1	0.1	53	0.1	0.1
10	0.1	0.1	32	0.1	0.1	54	2.6	2.5
11	0.1	0.1	33	0.1	0.1	55	0.1	0.1
12	0.1	0.1 - 3.3	34	0.1	0.1	56	0.1	0.1
13	1.7	0.0 - 3.3	35	3.3	3.3	57	1.4	1.4
14	1.6	0.1 - 3.3	36	0.1	0.1	58	1.4	1.4
15	0.1	0.1	37	0.1	0.1	59	2.6	2.6
16	0.1	0.1	38	0.1	0.1	60	1.7	1.7
17	0.1	0.1	39	0.1	0.1 - 3.3	61	2.6	2.6
18	2.6	2.5	40	0.1	0.1	62	1.2	1.2
19	0.1	0.1	41	0.1	0.1	63	1.3	1.2
20	0.1	0.1	42	2.5	2.5	64	0.1	0.1
21	0.1	0.1	43	0.1	0.1			
22	1.3	1.3	44	0.1	0.1			

IC801		
	CD-DA	MP3
1	0.1	0.1
2	3.3	3.3
3	2.6	2.6
4	0.0	0.0
5	3.3	3.3

IC802		
	CD-DA	MP3
1	0.1	0.1
2	3.3	3.3
3	2.6	2.6
4	0.0	0.0
5	3.3	3.3

	E		C		B	
	CD-DA	MP3	CD-DA	MP3	CD-DA	MP3
Q101	3.2	3.2	2.2	2.3	2.5	2.6
Q102	3.2	3.2	1.7	1.7	3.2	3.2
Q801	3.2	3.3	3.2	3.2	0.2	0.2
Q802	0.2	0.1	0.2	0.2	3.3	3.3

	1	2	3	4	5
Q803	0.1	3.3	3.3	5.1	0.1

[Measuring Conditions]

1. Power Supply Voltage : DC12V
2. Measuring Meter : Digital Multi Voltmeter
3. Measuring Point Reference : Between GND
4. Measuring Condition : CD-DA : TCD-782 Play
: MP3 : SCD-5577 Play

Description of IC Terminal

D784216AGC : IC001

No.	Symbol	I/O	Terminal Description
1	IF MUTE	O	IF MUTE control terminal. (H:IF MUTE ON)
2	NC	-	No connect terminal.
3			
4	RDS-CONT	O	RDS data input prevention control terminal of adjoining station. (H:RDS OFF)
5	IF MUTE(NC)	-	No connect terminal.
6	NC		
7			
8			
9	VDD	-	Power supply terminal.
10	X2	-	Crystal OSC connect terminal for main system clock OSC. (12.288MHz)
11	X1		
12	VSS	-	GND terminal.
13	XT2(NC)	-	No connect terminal.
14	XT1(GND)	-	GND terminal.
15	RESET	I	System reset input terminal.
16	BATT-DET	I	BATT compulsion stand-by signal input terminal from VDD IC.
17	STANDBY	I	Stand-by signal input terminal from Main μ -COM.
18	NC	-	No connect terminal.
19	IS BUS FIN	I	IS BUS frame signal input terminal.
20	NC	-	No connect terminal.
21			
22			
23	AVDD	-	Analog power supply terminal of A/D converter.
24	AVREF0	I	Standard voltage input terminal of A/D converter.
25	S-METER	I	Signal-Meter input terminal.
26	MULTIPATH	I	Multipath input terminal of RDS Decoder.
27	ADJCH-DET	I	Adjoining station detect input terminal.
28	SSTOP	I	FM station detect signal input terminal.
29	AMST/MP	I	SEEK STOP detect input terminal at AM. (H:Station ON)
30	AFC	I	FM station detect signal input terminal.
31	NC(GND)	-	GND terminal.
32			
33	AVSS	-	GND terminal of A/D converter.
34	NC	-	No connect terminal.
35			
36	AVREF1	I	Standard voltage input terminal of D/A converter.
37	IS BUS RX	I	IS BUS receiving terminal.
38	IS BUS TX	O	IS BUS transmitting terminal.
39	IS BUS FOUT	O	IS BUS frame signal output terminal.
40	MONITOR RXD	I	Command input terminal for RDS monitor (P/C). (Pull-up connect)
41	MONITOR TXD	O	Status output terminal for RDS monitor (P/C).
42	NC	-	No connect terminal.
43			
47			
48	T-MUTE	O	MUTE signal output terminal to Main μ -COM.
49	NC	-	No connect terminal.
50			

No.	Symbol	I/O	Terminal Description
51	MARKET1	I	Area set up terminal.
52	MARKET2		
53	MARKET3		
54	AUTO-ADJ	I	Auto adjustment start signal terminal of FM/AM TUNER. (L:start)
55	NC	-	No connect terminal.
I			
71			
72	VSS	-	GND terminal.
73	NC	-	No connect terminal.
I			
80			
81	VDD	-	Power supply terminal.
82	NC	-	No connect terminal.
I			
91			
92	PAUSE	I	Audio signal detect terminal. (L:Blank)
93	DAVN	I	Data available input terminal of RDS Decoder.
94	TEST/VPP	-	GND terminal.
95	RDS SDA	I/O	Data input/output terminal to RDS Decoder.
96	RDS SCL	O	Clock output terminal to RDS Decoder.
97	IIC SCL	O	IIC clock output terminal to TUNER-IC(TDA7511).
98	IIC SDA	I/O	IIC data input/output terminal to TUNER-IC(TDA7511).
99	TUNER ON(NC)	-	No connect terminal.
100	FM/AM	O	FM/AM power supply switching terminal. (L:FM)

M30624MWP : IC501

No.	Symbol	I/O	Terminal Description
1	NC	-	No connect terminal.
2	REMOCON DATA	I	Remote control data input terminal.
3	NC	-	No connect terminal.
4	SFSY	I	TEXT-DATA input terminal.
5	SBSY	O	TEXT-DATA reading clock output terminal.
6	GND	-	GND connect terminal.
7	CNVss(PULL-DOWN)	-	Pull-down connect terminal.
8	XCIN	I	Sub System clock OSC input terminal.
9	XCOUT	O	Sub System clock OSC output terminal.
10	RESET	I	System RESET input terminal.
11	XOUT	O	Main System clock OSC output terminal.
12	GND	-	GND connect terminal.
13	XIN	I	Main System clock OSC input terminal.
14	VCC	-	Power supply terminal.
15	NMI(PULL-UP)	-	Pull-up connect terminal.
16	8V-DET	I	8V-ON detect input terminal.
17	ACC-DET	I	ACC (IGNITION) detect signal input terminal.
18	BATT-DET	I	BATT detect signal input terminal.
19	NC	-	No connect terminal.
20	V-CONT(NC)	-	No connect terminal.
21	NC	-	No connect terminal.

No.	Symbol	I/O	Terminal Description
22	BUZZER	O	BUZZER signal output terminal.
23	BUS-IN	I	BUS signal input terminal.
24	CD RST	O	System reset signal output terminal to CD u-COM.
25	CD STBY	O	Stand-by request signal output terminal to CD u-COM.
26	NC	-	No connect terminal.
27	BUS IN	I	BUS signal input terminal.
28	BUS OUT	O	BUS signal output terminal.
29	RDS TXD	O	Command data signal output terminal to RDS u-COM.
30	RDS RXD	I	Status data signal input terminal from RDS u-COM.
31	NC	-	No connect terminal.
32	NC	-	No connect terminal.
33	CD TXD	O	Serial data signal output terminal to CD MECH.
34	CD RXD	I	Serial data signal input terminal from CD MECH.
35	#1 LCD AO	O	DATA/ADDRESS switching signal output terminal to LCD DRIVER.
	\$1 NC	-	No connect terminal.
36	LCD CE	O	CE signal output terminal to LCD DRIVER.
37	LCD INH	O	INH signal output terminal to LCD DRIVER.
38	NC	-	No connect terminal.
39	NC(PULL-UP)	-	Pull-up connect terminal.
40	NOSE PWR	O	Power supply control signal output terminal to around NOSE.
41	#1 LCD CE2	O	CE signal output terminal to LCD DRIVER.
	\$1 LCD STB	O	SHIFT Register control signal output terminal.
42	LCD DO	O	Serial data signal output terminal to LCD DRIVER.
43	LCD DI	I	Serial data signal input terminal from LCD DRIVER.
44	LCD CLK	O	Serial clock signal output terminal to LCD DRIVER.
45	ENCODER2	I	Encoder Data input terminal.
46	ENCODER1		
47	O-REM (PULL-UP)	-	Pull-up connect terminal.
48	PWR IC ON	O	Stand-by control signal output terminal of POWER-IC.
49	PWR CONT	O	Power control signal output terminal for AUDIO/LIGHTING.
50	NC	-	No connect terminal.
51	A-MUTE	O	Audio mute signal output terminal.
52	IN INT	I	Outer interrupt signal input terminal. (H : IN-INT)
53	P-ANT	O	Outer P-ANT control signal output terminal.
54	FAN CONT	O	FAN control signal output terminal.
55	IN DIMMER	I	Outer DIMMER detect signal input terminal.
56	BL LED	O	LED control signal output terminal for LCD back-right.
57	60W CONT	O	POWER-ON control output terminal for 60W.
58	ZERO DET	I	0bit mute signal input terminal from CD u-COM.
59	IIC-DATA	I/O	I2C Serial data signal input/output terminal.
60	VCC	-	Power supply terminal.
61	IIC-CLK	O	I2C Serial clock signal output terminal.
62	GND	-	GND connect terminal.
63	NC	-	No connect terminal.
64	NC	-	No connect terminal.
65	XRST	O	Reset signal output terminal of DSP-IC.
66	AREA	I	Area set up input terminal.
67	SCLK	O	Serial clock output terminal to DSP-IC.
68	RVDT	O	Serial data output terminal to DSP-IC.

NOTE : #1 : For CDA-9815R Model Only, \$1 : For CDA-9813R Model Only, Others : Common.

No.	Symbol	I/O	Terminal Description
69	TRDT	I	Serial signal input terminal from DSP-IC.
70	XLAT	O	Data latch signal output terminal to DSP-IC.
71	RDS FIN	I	Status data signal input terminal from RDS u-COM.
72	CLCK	I	Sub-code reading clock input terminal.
73	CD F-IN	I	FRAME signal input terminal.
74	CD F-OUT	O	FRAME signal output terminal.
75	REG RESET	O	Reset signal output terminal to System REG.-IC.
76	RDS RESET	OUT	RESET control signal output terminal to RDS u-COM.
77	T-MUTE	IN	A-MUTE signal input terminal from RDS u-COM.
78	RDS FOUT	O	Data signal output terminal to RDS u-COM.
79	RDS STBY	O	Stand-by signal output terminal to RDS u-COM.R
80	2way/3way	I	2WAY/3WAY switching signal input terminal. (H : 3way, L : 2way)
81	DOOR LED	O	ESC LED lighting control output terminal.
82	LIMIT SW1(OPEN)	I	OPEN LIMIT SW signal input terminal. (H : SW OFF, L : SW ON)
83	LIMIT SW2(CLOSE)	I	CLOSE LIMIT SW signal input terminal. (H : SW OFF, L : SW ON)
84	MOTOR ON	O	Power control signal output terminal for active NOSE Motor.
85	MOTOR FOR	O	Active NOSE Motor forward driving signal output terminal.
86	MOTOR REV	O	Active NOSE Motor backward driving signal output terminal.
87	HI-TEMP	I	HI-TEMP input terminal of CD mechanism.
88	DISC IN	I	DISC-IN detect signal input terminal of CD.
89	AUDIO	I	A/D DATA input terminal from AUDIO LEVEL signal.
90	NC	-	No connect terminal.
91	AFC	I	AFC input terminal.
92	NC	-	No connect terminal.
93	NC	-	No connect terminal.
94	GND	I	GND terminal of A/D converter.
95	NOSE DET	I	NOSE detect terminal.
96	VCC	-	Standard voltage input terminal of A/D converter.
97	VCC	-	Power supply input terminal of A/D converter.
98	NC	-	No connect terminal.
99	NC	-	No connect terminal.
100	NC	-	No connect terminal.

TMP91CP27U : IC104 (DP23S2DO)

No.	Symbol	I/O	Terminal Description
1	VREFL	-	GND terminal of A/D converter.
2	NC(PULL-DOWN)	-	Pull-down connect terminal.
3	E2CE(PULL-DOWN)		
4	NC(PULL-DOWN)		
5	NC(PULL-DOWN)		
6	QDATAF	O	Synchronous clock signal output terminal to Main u-COM.
7	/FIN	I	IS-BUS FRAME signal input terminal.
8	REQ	I	REQ signal input terminal.
9	/FOUT	O	IS-BUS FRAME signal output terminal.
10	NC(PULL-DOWN)	-	Pull-down connect terminal.
11	TXD(PF_IS)	O	PF-IS-BUS signal output terminal.
12	RXD(PF_IS)	I	PF-IS-BUS signal input terminal.

No.	Symbol	I/O	Terminal Description
13	NC(PULL-DOWN)	-	Pull-down connect terminal.
14	TXD(NC)	-	No connect terminal.
15	RXD(NC)		
16	NC		
17	AM0(PULL-UP)	-	Pull-down connect terminal.
18	DVCC	-	Power supply terminal. (+3.3V)
19	X2	O	Crystal OSC connect terminal. (27MHz)
20	DVSS	-	GND connect terminal.
21	X1	I	Crystal OSC connect terminal. (27MHz)
22	AM1(PULL-UP)	-	Pull-up connect terminal.
23	/RESET	I	RESET signal input terminal.
24	NC	-	No connect terminal.
25	NC		
26	NC(PULL-DOWN)	-	Pull-down connect terminal.
27	NC	-	No connect terminal.
28	BUS0	I/O	Data input/output terminal for Servo LSI I/F.
29	BUS1		
30	BUS2		
31	BUS3		
32	/BUCK	O	Clock output terminal for Servo LSI I/F.
33	/CCE	O	CE output terminal for Servo LSI I/F.
34	/CD_RESET	O	Reset control output terminal of Servo LSI.
35	ZMUTEIN	I	0 data detect flag input terminal.
36	NC(PULL-DOWN)	-	Pull-down connect terminal.
37	MUTE_O	O	MUTE request output terminal.
38	NC(PULL-DOWN)	-	Pull-down connect terminal.
39	GVSWS	O	CD-DARW detect output terminal. (H : CD-DA, L : RW)
40	/DR_MUTE	O	Motor driver MUTE control output terminal.
41	MOTOR1	O	Motor driver control output terminal.
42	MOTOR2	O	Motor driver control output terminal.
43	/LMT_SW	I	Pick-Up inside limit detect SW input terminal.
44	NC(PULL-DOWN)	-	Pull-down connect terminal.
45			
48			
49	CDVCONT	O	Servo power supply control output terminal.
50	/BOOT(NC)	-	No connect terminal.
51	NC	-	No connect terminal.
52	/DEC_RESET	O	Decoder reset control output terminal.
53	DEC_STANDBY	O	Decoder STANDBY control output terminal.
54	NC	-	No connect terminal.
55	NC	-	No connect terminal.
56	NC(PULL-DOWN)	-	Pull-down connect terminal.
57	SDA	I/O	I2C-BUS(SDA) signal input/output terminal.
58	SCL	O	I2C-BUS(SCL) signal output terminal.
59	/STBY	I	STANDBY signal input terminal.
60	/SWA	I	Disc Insert/pull out detect SW input terminal.
61	/SWB	I	8cm Disc EJECT/RELOAD detect SW input terminal.
62	/SWC	I	12cm Disc EJECT/RELOAD detect SW input terminal.
63	/SWD	I	Disc chucking end detect SW input terminal.
64	VREFH	-	Power supply terminal of A/D converter.